

Use, Care, and Installation Guide

Firenze

ZFI-M90S

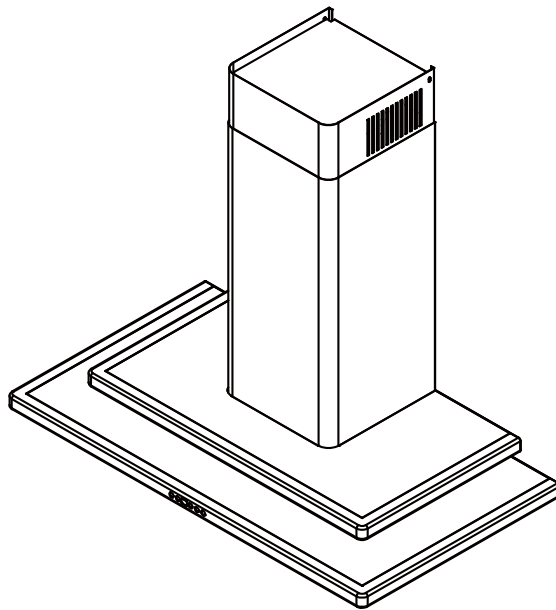

C US

Model number: _____

Serial Number: _____

SAFETY NOTICE 2-3

LIST OF MATERIALS 4

INSTALLATION

 Ducting Calculation Sheet 5

 Mounting Height & Clearance..... 6

 Ducting Options 7

 Hood Specifications 8

 Mounting the Range Hood 9

 Ductless Recirculating 10

FEATURES & CONTROLS

 Touch Controls 11

 Charcoal Filter Replace Reminder 12

 Metal Mesh Filter Clean Reminder 13

MAINTENANCE

 Hood and Filter Cleaning 14

 Lights 15

TROUBLESHOOTING..... 16

LIST OF PARTS AND ACCESSORIES 17

Important Safety Notice

WARNING

TO REDUCE THE RISK OF FIRE OR ELECTRIC SHOCK, DO NOT USE THIS FAN WITH ANY SOLID-STATE CONTROL DEVICE.

WARNING

TO REDUCE THE RISK OF FIRE ELECTRIC SHOCK, OR INJURY TO PERSONS, OBSERVE THE FOLLOWING:

- a. Use this unit only in the manner intended by the manufacturer, if you have questions, contact the manufacturer.
- b. Before servicing or cleaning unit, switch power off at service panel and lock panel to prevent power from being switched on accidentally. When the service disconnecting means cannot be locked, securely fasten a prominent warning device, such as a tag, to the service panel.

CAUTION

For general ventilating use only. Do not use to exhaust hazardous or explosive materials and vapors. Take care when using cleaning agents or detergents. Suitable for use in household cooking area.

WARNING

TO REDUCE THE RISK OF RANGE TOP GREASE FIRE:

- a. Never leave surface units unattended at high settings. Boilovers cause smoking and greasy spillovers that may ignite. Heat oils slowly on low or medium settings.
- b. Always turn hood ON when cooking at high heat or when flaming food
- c. Clean ventilating fans frequently. Grease should not be allowed to accumulate on fan or filter.
- d. Use proper pan size. Always use cookware appropriate for the size of the surface element.
- e. Keep fan, filters and grease laden surfaces clean.
- f. Use high setting on hood only when necessary.
- g. Don't leave hood unattended when cooking.
- h. Always use cookware and utensils appropriate for the type of and amount of food being prepared.

WARNING

TO REDUCE THE RISK OF INJURY TO PERSONS IN THE EVENT OF A RANGE TOP FIRE, OBSERVE THE FOLLOWING:

- a. SMOTHER FLAMES with a close-fitting lid, cookie sheet, or metal tray, then turn off the burner. BE CAREFUL TO PREVENT BURNS. If the flames do not go out immediately, EVACUATE AND CALL THE FIRE DEPARTMENT.
- b. NEVER PICK UP A FLAMING PAN – You may be burned.
- c. DO NOT USE WATER, including wet dishcloths or towels – a violent steam explosion will result.
- d. Use an extinguisher ONLY if:
 - 1. You know you have a Class ABC extinguisher, and you already know how to operate it.
 - 2. The fire is small and contained in the area where it started.
 - 3. The fire department is being called.
 - 4. You can fight the fire with your back to an exit

WARNING

TO REDUCE THE RISK OF FIRE, ELECTRIC SHOCK OR INJURY TO PERSONS, OBSERVE THE FOLLOWING:

- a. Installation work and electrical wiring must be done by qualified person(s) in accordance with all applicable codes and standards. Including re-rated construction.
- b. Sufficient air is needed for power combustion and exhausting of gases through the flue (chimney) of fuel burning equipment to prevent back-drafting. Follow the heating equipment manufacturer's guideline and safety standards such as those published by the National Fire Protection Association (NFPA) and the American Society for Heating, Refrigeration and Air Conditioning Engineers (ASHRAE) and the local code authorities.
- c. When cutting or drilling into wall or ceiling, do not damage electrical wiring and other hidden utilities.
- d. Ducted fans must always vent to the outdoors.
- e. If this unit is to be installed over a tub or shower, it must be marked as appropriate for the application and be connected to a GFI (Ground Fault Interrupter protected branch circuit).
- g. NEVER place a switch where it can be reached from a tub or shower.
- h. Make sure the power is off before installing, wiring or maintaining.

WARNING

TO REDUCE THE RISK OF FIRE, USE ONLY METAL DUCTWORK.

CAUTION

To reduce risk of fire and to properly exhaust air outside - Do not vent exhaust air into spaces within walls, ceilings, attics, crawl spaces or garages.

OPERATION

Always leave safety grilles and filters in place. Without these components, operating blowers could catch onto hair, fingers and loose clothing.

The manufacturer declines all responsibility in the event of failure to observe the instructions given here for installation, maintenance and suitable use of the product. The manufacturer further declines all responsibility for injury due to negligence and the warranty of the unit automatically expires due to improper maintenance.

***NOTE: Please check www.zephyronline.com for revisions before doing any custom work.**

ELECTRICAL REQUIREMENTS

Important:

Observe all governing codes and ordinances.

It is the customer's responsibility:

- To contact a qualified electrical installer.
- To assure that the electrical installation is adequate and in conformance with National Electrical Code, ANSI/NFPA 70 latest edition* or CSA standards C22.1-94, Canadian Electrical Code, Part 1 and C22.2 No.0-M91 - latest edition** and all local codes and ordinances.

If codes permit and a separate ground wire is used, it is recommended that a qualified electrician determine that the ground path is adequate.

Do not ground to a gas pipe.

Check with a qualified electrician if you are not sure the range hood is properly grounded.

Do not have a fuse in the neutral or ground circuit.

*National Fire Protection Association Batterymarch Park, Quincy, Massachusetts 02269

** CSA International 8501 East Pleasant Valley Road, Cleveland, Ohio 44131-5575

This appliance requires a 120V 60Hz electrical supply and connected to an individual properly grounded branch circuit protected by a 15 or 20 ampere circuit breaker or time delay fuse. Wiring must be 2 wire with ground. Please also refer to Electrical Diagram on product.

A cable locking connector (not supplied) might also be required by local codes. Check with local requirements, purchase and install appropriate connector if necessary.

ZFI-M90S - 400 Watts, 3.3 Amps

List of Materials

MODELS: ZFI-M90S

PARTS SUPPLIED

- 1 - Hood with internal blower
- 2 - Metal mesh filters
- 1 - Duct cover assembly (*top and bottom*)
- 1 - Duct cover wall bracket
- 2 - 50W GU-10 halogen light bulbs
- 1 - 6" round backdraft damper (*pre-installed*)
- 1 - Hardware package

HARDWARE PACKAGE CONTENTS

M4 x 3/8" (2)



M4 x 1-1/4" (3)

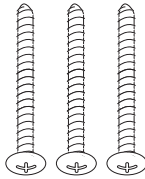

M4 x 1" (2)

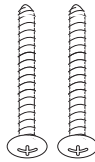

Suction Cup (1)

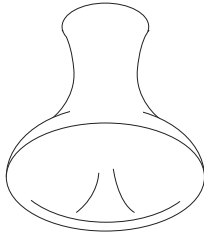



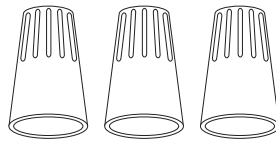



Wire Nuts (3)



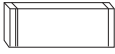

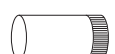
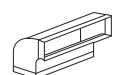
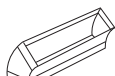

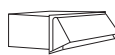
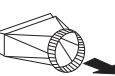
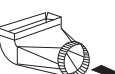

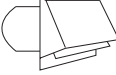

PARTS NOT SUPPLIED

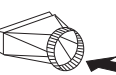
- Ducting, conduit and all installation tools
- Cable connector (if required by local codes)
- Duct cover extension accessory
- Recirculating kit accessory

Installation – Ducting Calculation Sheet

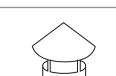
Duct pieces		Equivalent number length x used =	Total
	3-1/4" x 10" Rect., straight	1 Ft. x () =	Ft.
	7" Round, straight	1 Ft. x () =	Ft.
	8" Round, straight	1 Ft. x () =	Ft.
	3-1/4" x 10" Rect. 90° elbow	15 Ft. x () =	Ft.
	3-1/4" x 10" Rect. 45° elbow	9 Ft. x () =	Ft.
	3-1/4" x 10" Rect. 90° flat elbow	24 Ft. x () =	Ft.
	3-1/4" x 10" Rect. wall cap with damper	30 Ft. x () =	Ft.
	3-1/4" x 10" Rect. to 6" round transition	5 Ft. x () =	Ft.
	3-1/4" x 10" Rect. to 6" round transition 90° elbow	20 Ft. x () =	Ft.
	6" Round, 90° elbow	15 Ft. x () =	Ft.
	6" Round, 45° elbow	9 Ft. x () =	Ft.
Subtotal column 1 =			Ft.

Duct pieces		Equivalent number length x used =	Total
	6" - 8" Round wall cap with damper	30 Ft. x () =	Ft.
	6" - 8" Round, roof cap	30 Ft. x () =	Ft.
	6" round to 3-1/4" x 10" rect. transition	1 Ft. x () =	Ft.
	6" round to 3-1/4" x 10" rect. transition 90° elbow	16 Ft. x () =	Ft.
	7" or 8" Round, 90° elbow	15 Ft. x () =	Ft.
	7" or 8" Round, 45° elbow	9 Ft. x () =	Ft.
	7" or 8" Round wall cap with damper	30 Ft. x () =	Ft.
	7" or 8" Round, roof cap	30 Ft. x () =	Ft.
	7" round to 3 1/4" x 10" rect. transition	8 Ft. x () =	Ft.
	7" round to 3-1/4" x 10" rect. transition 90° elbow	23 Ft. x () =	Ft.
Subtotal column 2 =			Ft.
Subtotal column 1 =			Ft.
Total ductwork =			Ft.

Maximum Duct Length: For satisfactory air movement, the total duct length of a 3 1/4" x 10" rectangular 6" or 7" diameter round duct should not exceed 100 equivalent feet.

Installation – Mounting Height & Clearance

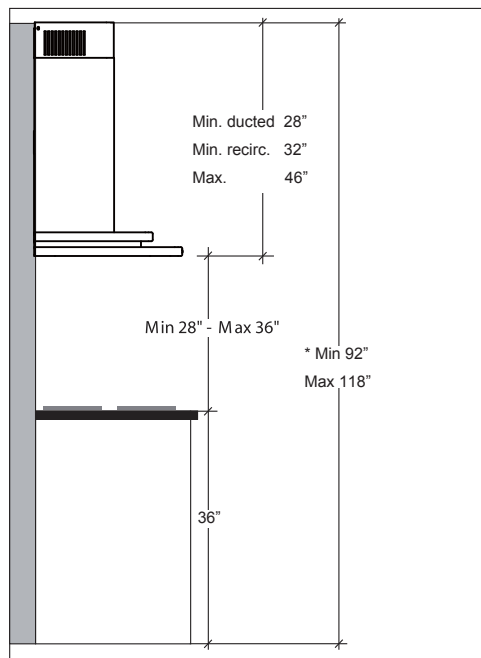

* The min ceiling height is 96" for recirculating option

DUCTING

A minimum of 6" round duct must be used to maintain maximum air flow efficiency.

Always use rigid type metal ducts only. Flexible ducts could restrict air flow by up to 50%.

Use calculation worksheet to compute total duct work (Page 5).

ALWAYS, when possible, reduce the number of transitions and turns. If a long duct run is required, increase duct size from 6" to 7" or 8".

If turns or transitions are required: Install as far away from duct opening and as far apart between the two transitions as possible.

Minimum mount height between range top to hood bottom should be no less than 28".

Maximum mount height should be no higher than 36".

It is important to install the hood at the proper mounting height. Hoods mounted too low could result in heat damage and fire hazard; while hoods mounted too high will be hard to reach and will lose its performance and efficiency.

If available, also refer to range manufacturer's height clearance requirements and recommended hood mounting height above range. Always check your local codes for any differences.

Minimum Mounting Height (Ducted)

7'8". Hood mounted 28" above cooking surface; 64" from floor.

Minimum Mounting Height (Recirculating)

8'. Hood mounted 28" above cooking surface; 64" from floor.

Maximum Mounting Height

9'10". Hood mounted 36" above cooking surface; 72" from floor.

Duct cover extension kit available for ceiling heights up to 14 feet. Turn to page 17 for part number and ordering information.

DAMAGE-SHIPMENT / INSTALLATION:

- Please fully inspect unit for damage before installation.
- If the unit is damaged in shipment, return the unit to the store in which it was bought for repair or replacement.
- If the unit is damaged by the customer, repair or replacement is the responsibility of the customer.
- If the unit is damaged by the installer (if other than the customer), repair or replacement must be made by arrangement between customer and installer.

WARNING FIRE HAZARD

NEVER exhaust air or terminate duct work into spaces between walls, crawl spaces, ceiling, attics or garages. All exhaust must be ducted to the outside, unless using the recirculating option.

Use single wall rigid Metal ductwork only.

Fasten all connections with sheet metal screws and tape all joints w/ certified Silver Tape or Duct Tape.

Some Ducting Options

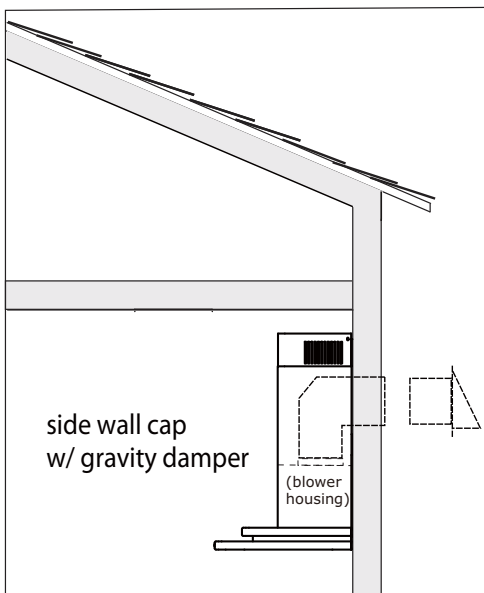
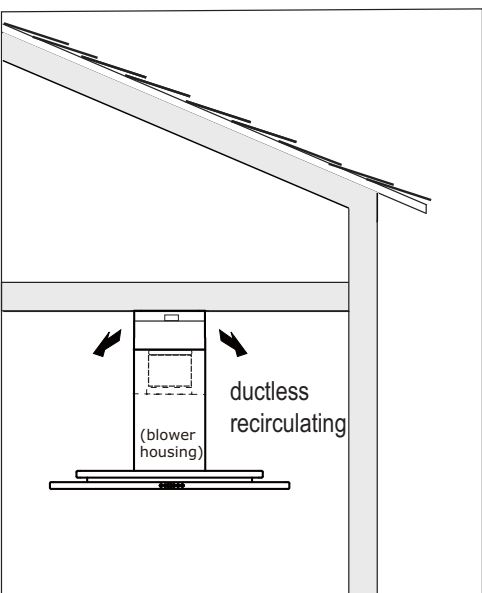
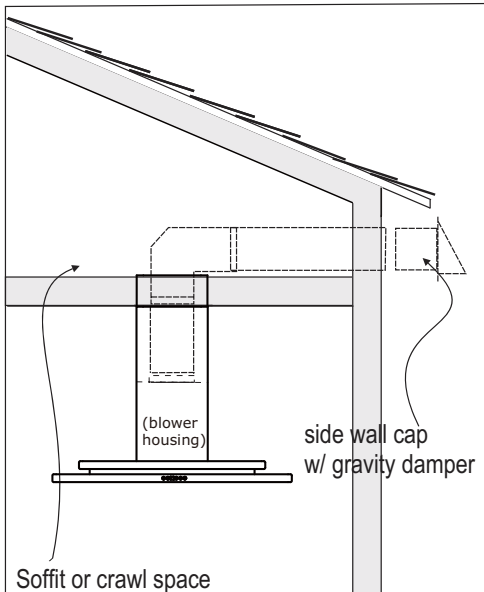
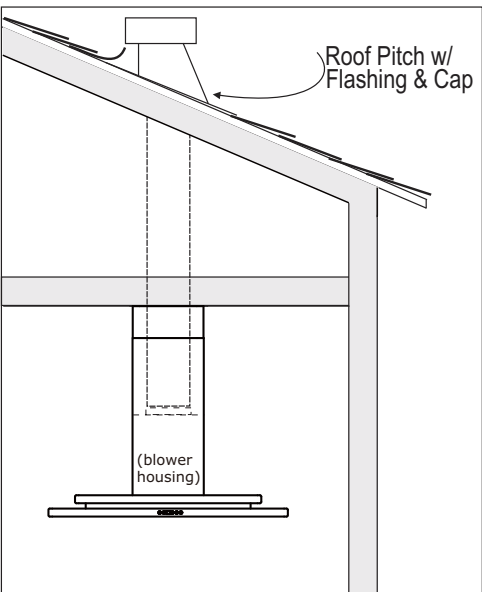

Installation – Hood Specifications

FRONT VIEW

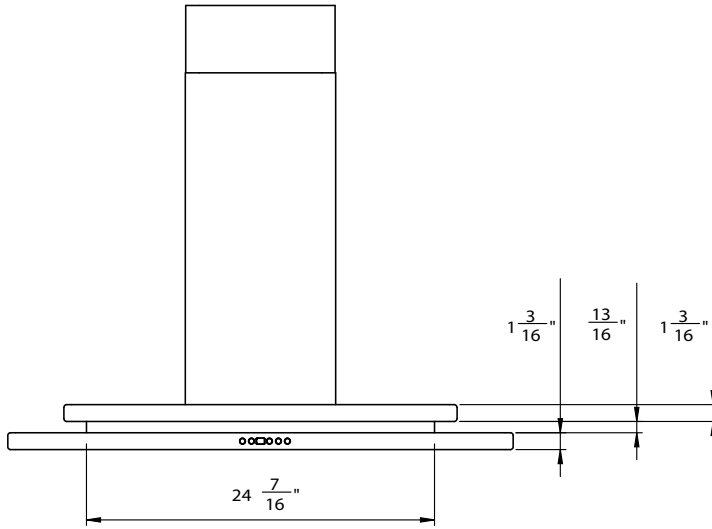

SIDE VIEW

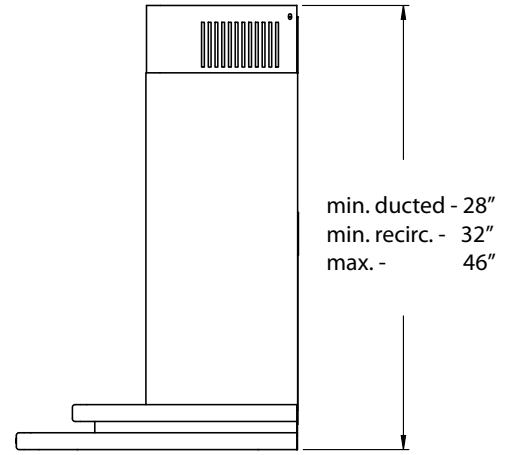

TOP VIEW

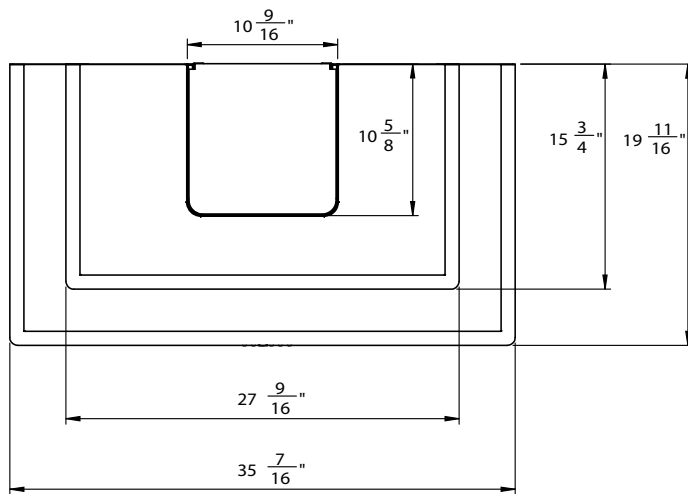

⚠ CAUTION: At least two installers are required due to the weight and size of the hood.

1. Measure from range top to hood bottom and mark line A. (28" minimum from range top) .
2. Plum and mark center line.
3. Mark mounting height line B. (16" from line A)
4. Mark mounting spread from C/L. (8-7/8")
5. Fasten (2) M4 x 1-1/2" screws into studs on line B but do not tighten all the way. **Note: Wood blocking may need to be added behind the drywall if no studs are present. Wall anchors may also be used but check local codes before using wall anchors.**
6. Remove the (2) metal mesh filters.
7. Remove the (2) charcoal filter brackets located inside the hood behind the metal mesh filters. Each bracket is secured with (4) 3/16 x 6 Philips head screws. **Note: If you are not recirculating the hood you may discard the charcoal brackets.**
8. Hang hood onto the mounting screws and hand tighten each screw. (f g A) Secure third M4 x 1-1/2" screw through inside of hood into wall for extra support. (f g A2)
9. Center and attach duct cover mounting bracket to wall just below the ceiling or soffit using (2) M4 x 1" screws.
10. Install electrical and duct work. Seal duct work with aluminum duct tape.
11. Power up hood and check for leaks around duct tape.
12. Place telescopic duct covers onto hood and extend inner (top) duct cover upwards and secure to duct cover bracket using (2) M3.5 x 8 screws. Secure bottom duct cover to hood body by also using (2) M3.5 x 8 screws.

* If using hood in recirculating mode you must secure the air diverter plate onto wall before installing duct work and duct covers. Turn to page 10 for more details.

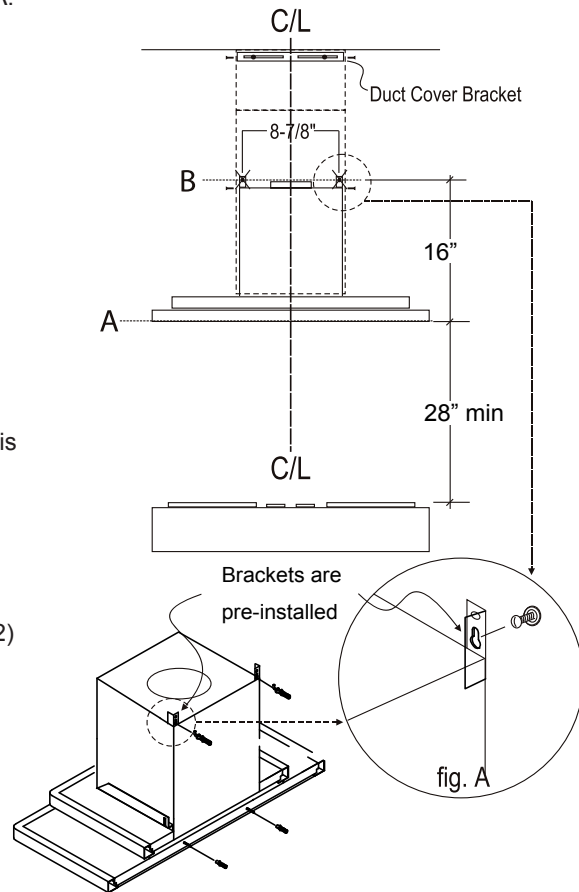

⚠ WARNING: Electrical wiring must be done by a qualified person(s) in accordance with all applicable codes and standards. This range hood must be properly grounded. Turn off electrical power at service entrance before wiring.

Cable Lock

A cable locking connector (not supplied) might be required by local codes. Check with local requirements and codes, purchase and install appropriate connector if necessary.

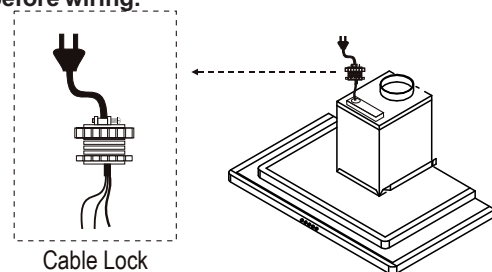

Ductless recirculation is intended for applications where an exhaust duct work is not possible to be installed. When converted, the hood functions as a recirculating hood rather than an exhaust hood. Fumes and exhaust from cooking are drawn and filtered by a set of optional charcoal filters. The air is then purified and re-circulated back within the home.

We recommend to ALWAYS exhaust air outside of the home by employing existing or installing new duct work, if possible. The hood is most effective and efficient as an exhaust hood. Only when the exhaust option is not possible should you recourse to converting the hood into a recirculating hood.

When converted to be a recirculating hood, a set of charcoal filters are required on top of its standard Metal Filter set. Order according to its Part number below. The standard Metal Filters are intended to capture residue from cooking and the optional charcoal filters help to purify fumes exhausted from cooking for recirculation.

RECIRCULATING KIT (REQUIRED IF NO DUCTING IS USED)

Kit includes charcoal filters and air diverter plate.

Hood Model	Part No.	Filters in Pkg.
ZFI-M90S	ZRC-0020	2

1. Purchase recirculating kit per the part number above
2. Secure air diverter plate to wall below duct cover bracket. (FIG. B) Run 6" ducting from top of hood and secure to air diverter plate. See manual included with recirculating kit for more detailed instructions.
3. Remove metal mesh filters from hood. Clip charcoal filters onto each charcoal filter bracket. (FIG. C) The brackets are pre-installed and located behind the mesh filters.
4. Re-Install metal mesh filters.
5. Enable charcoal filter change indicator on control panel. (Refer details to pg. 12)
6. Charcoal filters must be replaced after every 120 hours of use (or approximately every 3 to 4 months based on the average of 1 - 2 hrs. of daily cooking time). The microprocessor in the controls when set, will elapse and count usage time and indicate when charcoal filter replacement is required every 120 hrs.

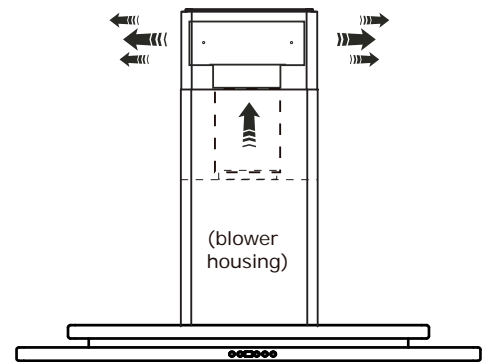

FIG. B

Charcoal Filter Replacements

Hood Model	Part No.	Qty to Order
ZFI-M90S	Z0F-C002	2

DO NOT WASH CHARCOAL FILTERS. Charcoal filters may need to be changed more often depending on cooking habits.

Charcoal Filter Dimensions:
9in x 6 3/8in
228mm x 162mm

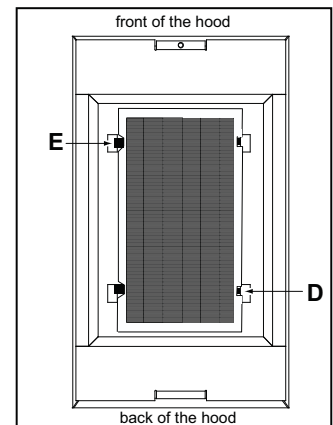

Install charcoal filter (plastic side exposed) into charcoal filter bracket. Insert tab cut-out side D of charcoal filter into bracket first. Lock charcoal filter into place by pushing down on side E with locking tabs.

FIG. C

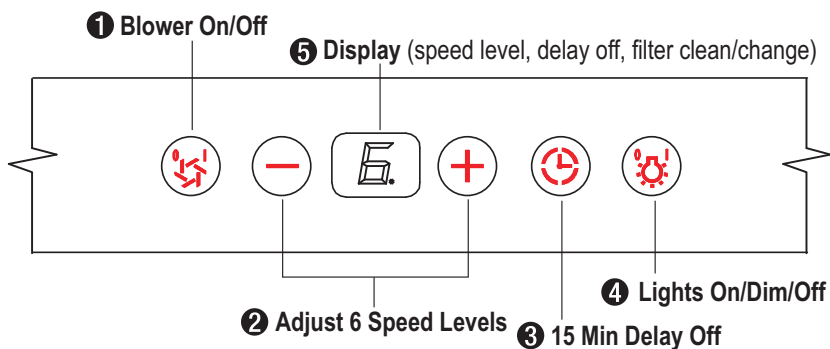

1. Blower On/Off

By pressing the blower is switched on and off. When switched on, the blower starts up on speed level 3.

2. Speed Selection

The 6 speed levels are selected by pressing to decrease and to increase speed levels. The display indicates levels selected.

3. Delay Off

This feature is used for programmed shut down of the blowers 15 minutes after the function is activated. Press once, a dot flashes in the lower right side of display indicating the function is on. The blowers will shut down after 15 minutes.

4. Lights On/Dim/Off

Switch lights on by pressing once, press a second time to dim and again to shut off lights.

5. Display Window

The display window indicates speed levels and features such as metal filter clean reminder, delay off and charcoal filter change reminder.

Metal Filter Clean Reminder (metal mesh filter)

After every 30 hours of use the display will start flashing an reminding you to clean the metal filters from residue and possible clogs.



The standard metal mesh filters are required to be cleaned frequently and as recommended in order to maintain blower efficiency. If improperly maintained, residue from cooking will sift through filters and cause damage to hood blowers and other sensitive components; and possible clog duct work and create a fire hazard.

Charcoal Filter Change Reminder (charcoal filter, if installed)

When your hood is installed as a recirculating unit, it is fitted with a set of charcoal filters to purify exhaust and fumes from cooking, then re-circulates the air within the home. These charcoal filters are required to be replaced after every 120 hours of use. The charcoal filters should never be cleaned or placed in a dish washer.

The filter change reminder function in the microprocessor needs to be switched on. When switched on, the microprocessor will elapse and count usage time and indicate by a flashing  when charcoal filter replacements are needed.



Setting the Filter Change Reminder

When off, hold  for approximately 5 seconds. The display will change from  (exhaust mode) to  (recirculating mode) this indicates that the elapse timer function is switched on and charcoal filters are used.

Filter Replace Indicator

When the display  starts flashing, the charcoal filters need to be replaced.

Re-setting Function

Once filters are replaced, with hood off, press and hold  the display will appear; hold for approximately 5 seconds until  on displays disappears . The filter change reminder is now re-set and a new 120 hour elapse cycle is initiated.

Set Mode

hold 5 sec. display from < - > to < C >

**Change Filters**

display < C > flashes

**To Reset**

hold 5 sec. display from < C > to < >





Metal Filter Clean Reminder (metal mesh filter)

Whether your hood is installed as an exhaust or purifying unit, a set of metal mesh filters are fitted by the factory. These metal mesh filters are intended to filter out residue from cooking. They need not be replaced on a regular basis but are required to be kept clean. The filter clean reminder function in the microprocessor will automatically indicate by a flashing  when the metal mesh filters need to be cleaned after every 30 hours of use. Filters can be cleaned by hand with non-abrasive soap or in a dishwasher. Heavily soiled filters should also be soaked in grease cutting detergent prior to cleaning.

Metal Filter Clean Indicator

When  flashes on display, the metal filters installed are required to be cleaned. This will occur after every 30 hours of use.

Re-setting Function

Reset the filter clean reminder timer when filters are cleaned and re-installed (with hood off). Press and hold  for approximately 5 seconds, the display will appear; hold for approximately 5 seconds until  on display disappears . The filter clean reminder function is now reset and a new 30 hours elapse cycle is initiated.

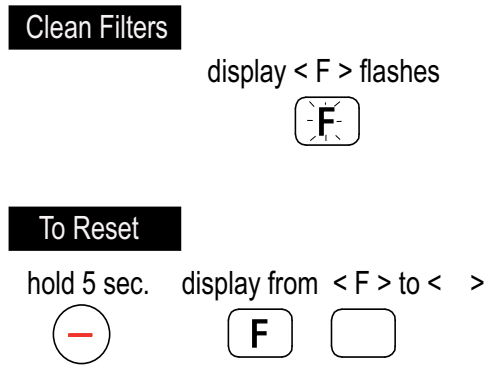

SURFACE MAINTENANCE:

Clean periodically with hot soapy water and clean cotton cloth. Do not use corrosive or abrasive detergent , or steel wool/scouring pads which will scratch and damage surface.

For heavier soil use liquid degreaser.

After cleaning it is recommended that you use non-abrasive stainless steel polish/cleaners, to polish and buff out the stainless luster and grain. Always scrub lightly, with clean cotton cloth, and with the grain.

Do not use any product containing chlorine bleach. Do not use “orange” cleaners.

Metal Mesh Filters

The metal mesh filters installed by the factory are intended to filter out residue and grease from cooking. They need not be replaced on a regular basis but are required to be kept clean.

After 30 hours of use the letter “A” will flash on the control screen indicating time to clean the metal mesh filters. Refer to instructions on page 13 on how to reset the indicator. Filters may need to be cleaned more depending on cooking habits.

Remove and clean by hand or in dishwasher on low heat. Spray degreasing detergent and leave to soak if heavily soiled.

Dry filters and re-install before using hood.

Removing Metal Mesh Filters

1. Push in on spring loaded handle
2. Pull down on filter handle to remove filter

Should filters wear out due to age and prolonged use, replace with following part number:

Hood Model:	Part No.	Qty to Order
ZFI-M90S	50200011	2

Metal Mesh Filter Dimensions:

10 1/8in. x 12 9/16in.
253mm x 314mm

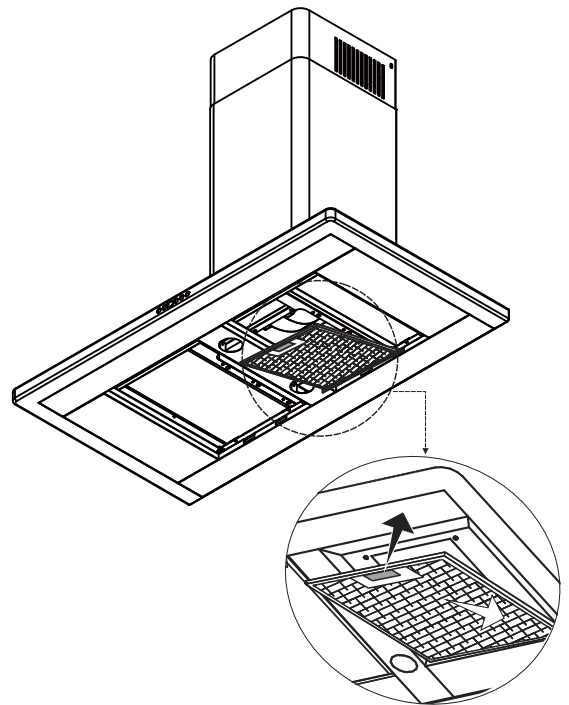

REPLACING LIGHT BULBS

CAUTION: Light bulb becomes extremely hot when turned on.

DO NOT touch bulb until switched off and cooled. Touching hot bulbs could cause serious burns.

Make sure all power is turned off and bulbs are not hot.

Remove by turning bulb counter clockwise. Note: Bulb does not unscrew; it turns 60 degrees, stops and falls out.

If bulbs are difficult to turn due to prolonged use, firmly attach a glass suction cup approximately the diameter of the bulb or use a rubber/latex glove and turn counter clockwise.

Replacement bulbs are available at specialty lighting stores. Purchase type GU-10 50W halogen.

For Zephyr part numbers please turn to page 17 of the manual.

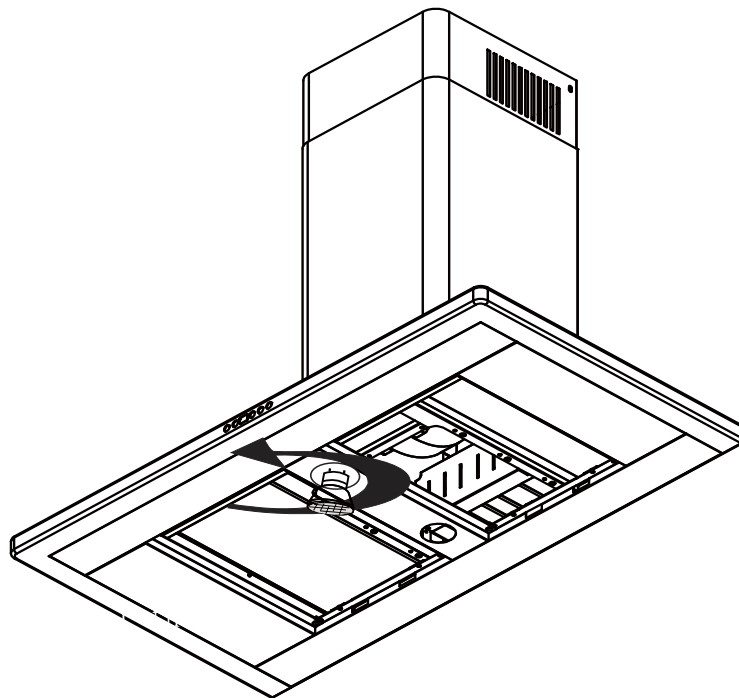

TROUBLESHOOTING PROCEDURES FOR FIRENZE

Issue	Cause	What to do
After installation, the unit doesn't work.	1. The power source is not turned ON.	1. Make sure the circuit breaker and the unit's power is ON.
	2. The power line and the cable locking connector is not connecting properly.	2. Check the power connection with the unit is connected properly.
	3. The switch board and control board wirings are disconnected.	3. Make sure the wirings between the switch board and control board are connected properly.
	4. The switch board or control board is defective.	4. Change the switch board or control board.
Light works, but motor is not turning.	1. The motor is defective, possibly seized.	1. Change the motor.
	2. The thermally protected system detects if the motor is too hot to operate and shuts the motor down.	2. The motor will function properly after the thermally protected system cool down.
	3. Damaged capacitor.	3. Change the capacitor.
	4. The switch board or control board is defective.	4. Change defective part.
The unit is vibrating.	1. The motor is not secure in place.	1. Tighten the motor in place.
	2. Damaged blower wheel.	2. Replace the blower.
	3. The hood is not secured in place.	3. Check the installation of the hood.
	4. The switch board or control board is defective.	4. Change defective part.
The motor is working, but the lights are not.	1. Defective halogen bulb.	1. Change the halogen bulb.
	2. The light bulb is loose.	2. Tighten the light bulb.
The hood is not venting out properly.	1. The hood might be hanging to high from the cook top.	1. Adjust the distance between the cook top and the bottom of the hood within 28" and 36" range.
	2. The wind from the opened windows or opened doors in the surrounding area are affecting the ventilation of the hood.	2. Close all the windows and doors to eliminate the outside wind flow.
	3. Blockage in the duct opening or ductwork.	3. Remove all the blocking from the duct work or duct opening.
	4. The direction of duct opening is against the wind.	4. Adjust the duct opening direction.
	5. Using the wrong size of ducting.	5. Change the ducting to at least 6" or higher for the internal blower and 8" or higher for the external blower.
Metal Filter is vibrating.	1. Metal filter is loose.	1. Change the metal filter.

DESCRIPTION	PART#
Replacement Parts	
Light Bulb GU-10 50W (each)	Z0B-0020
Metal Mesh Filter (each)	50200011
Optional Accessories	
Recirculating Kit	ZRC-0020
Replacement Charcoal Filter	Z0F-C002
Duct Cover Extension	Z1C-00FI

To order parts, visit us online at <http://store.zephyronline.com> or call us at 1.888.880.8368

ZEPHYR

Limited Warranty

STAPLE YOUR RECEIPT HERE
Proof of the original purchase
date is needed to obtain
service under warranty

TO OBTAIN SERVICE UNDER WARRANTY OR FOR ANY SERVICE RELATED QUESTIONS, please call:
1-888-880-8368

Zephyr Corporation (referred to herein as “we” or “us”) warrants to the original consumer purchaser (referred to herein as “you” or “your”) of Zephyr products (the “Products”) that such Products will be free from defects in materials or workmanship as follows:

Two Year Limited Warranty for Parts: For two years from the date of your original purchase of the Products, we will provide, free of charge, Products or parts to replace those that failed due to manufacturing defects. We may choose, in our sole discretion, to repair or replace parts before we elect to replace the Products.

One Year Limited Warranty for Labor: For one year from the date of your original purchase of the Products, we will provide, free of charge, the labor cost associated with repairing the Products or parts to replace those that failed due to manufacturing defects. After the first year from the date of your original purchase, you are responsible for all labor costs associated with this warranty.

Warranty Exclusions: This warranty covers only repair or replacement, at our option, of defective Products or parts and does not cover any other costs related to the Products including but not limited to: (a) normal maintenance and service required for the Products and consumable parts such as light bulbs, metal and carbon filters and fuses; (b) any Products or parts which have been subject to freight damage, misuse, negligence, accident, faulty installation or installation contrary to recommended installation instructions, improper maintenance or repair (other than by us); (c) commercial use of the Products or use otherwise inconsistent with its intended purpose; (d) natural wear of the finish of the Products or wear caused by improper maintenance, use of corrosive and abrasive cleaning products, pads, and oven cleaner products; (e) chips, dents or cracks caused by abuse or misuse of the Products; (f) service trips to your home to teach you how to use the Products; or (g) damage to the Products caused by accident, fire, floods or act of God. If you are outside our service area, additional charges may apply for shipping costs for warranty repair at our designated service locations and for the travel cost to have a service technician come to your home to repair, remove or reinstall the Products. After the first year from the date of your original purchase, you are also responsible for all labor costs associated with this warranty.

Limitations of Warranty. OUR OBLIGATION TO REPAIR OR REPLACE, AT OUR OPTION, SHALL BE YOUR SOLE AND EXCLUSIVE REMEDY UNDER THIS WARRANTY. WE SHALL NOT BE LIABLE FOR INCIDENTAL, CONSEQUENTIAL OR SPECIAL DAMAGES ARISING OUT OF OR IN CONNECTION WITH THE USE OR PERFORMANCE OF THE PRODUCTS. THE EXPRESS WARRANTIES IN THE PRECEDING SECTION ARE EXCLUSIVE AND IN LIEU OF ALL OTHER EXPRESS WARRANTIES. WE HEREBY DISCLAIM AND EXCLUDE ALL OTHER EXPRESS WARRANTIES FOR THE PRODUCTS, AND DISCLAIM AND EXCLUDE ALL WARRANTIES IMPLIED BY LAW, INCLUDING THOSE OF MERCHANTABILITY AND FITNESS FOR A PARTICULAR PURPOSE. Some states or provinces do not allow limitations on the duration of an implied warranty or the exclusion or limitation of incidental or consequential damages, so the above limitations or exclusions may not apply to you. To the extent that applicable law prohibits the exclusion of implied warranties, the duration of any applicable implied warranty is limited to the same two-year period described above. Any oral or written description of the Products is for the sole purpose of identifying the Products and shall not be construed as an express warranty. Prior to using, implementing or permitting use of the Products, you shall determine the suitability of the Products for the intended use, and you shall assume all risk and liability whatsoever in connection with such determination. We reserve the right to use functionally equivalent refurbished or reconditioned parts or Products as warranty replacements or as part of warranty service. This warranty is not transferable from the original purchaser and applies in the United States and Canada.

To Obtain Service Under Limited Warranty: To qualify for warranty service, you must: (a) notify us at the address or telephone number stated below within 60 days of the discovery of the defect; (b) give the model number and part identification number and serial number; and (c) describe the nature of any defect in the Product or part. At the time of the request for warranty service, you must present evidence of your proof of purchase and proof of the original purchase date. If we determine that the warranty exclusions listed above apply or if you fail to provide the necessary documentation to obtain service, you will be responsible for all shipping, travel, labor and other costs related to the services.

Please check our website for any revisions, www.zephyronline.com.

Zephyr Corporation Service Department, 2277 Harbor Bay Parkway, Alameda, CA 94502 1-888-880-8368