

## ZRC-0080

For use with models: AK8000CS, AK8100BS

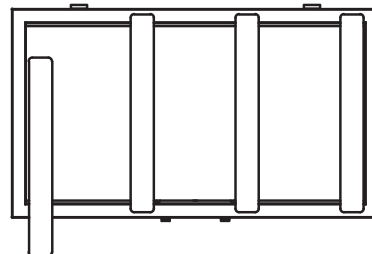
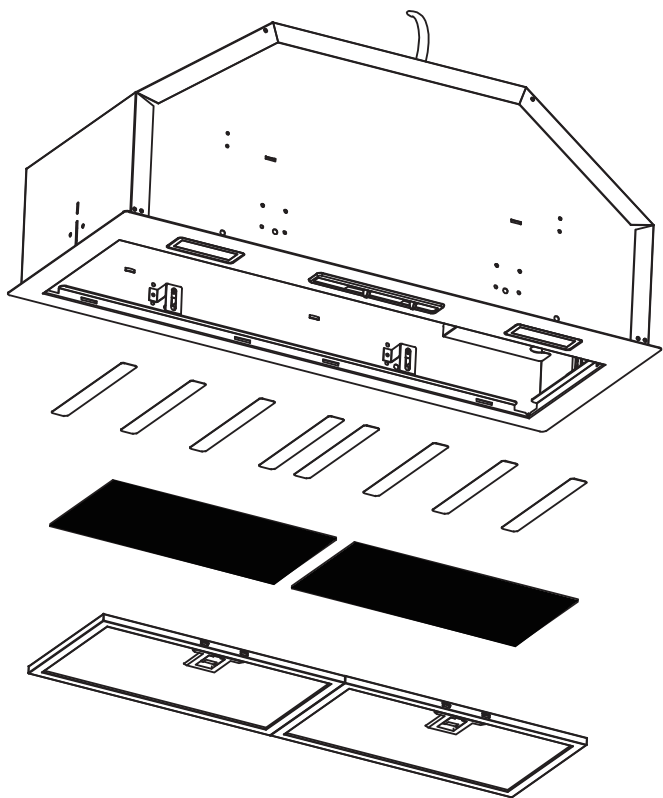

Place charcoal filter on back-side of filter. And place filter brackets over charcoal filter and secure in place by tucking each end of bracket under the filter frame. Re-install filter.

### INCLUDED MATERIALS

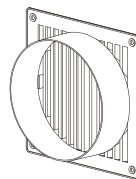

(1) return air vent



(4) return air vent screws



(2) charcoal filters

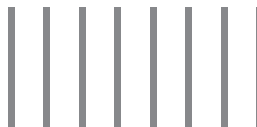

(8) Brackets

Turn to next page for instructions on installing return air vent.

### To install the return air vent to top of the cabinet:

(for installations where cabinet does not extend to the ceiling)

1. Cut a 6-1/2" round opening in top of the cabinet where the ducting will connect to the return air vent. **FIG.1**
2. Connect 6" round ducting from **AK8000CS**/AK8100BS to return air vent collar. Return air vent collar will go around the ducting. Secure with duct tape.
3. Secure return air vent to top of cabinet with (4) screws.

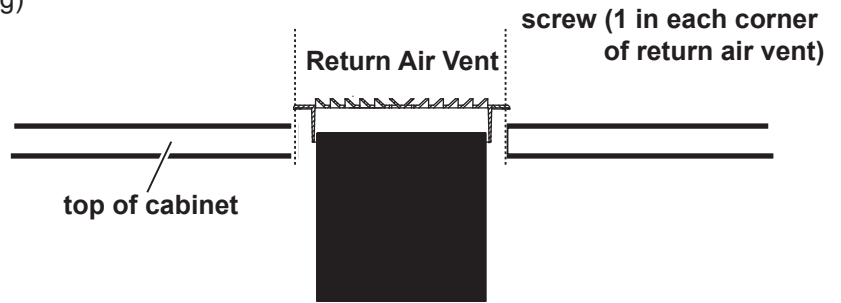

FIG.1

### To install the return air vent to a soffit or ceiling:

(for installations where top of cabinet is flush with the ceiling)

1. Cut a 6-1/2" round opening in soffit or ceiling where the ducting will connect to the return air vent. **FIG.2**
2. Connect 6" round ducting from **AK8000CS**/AK8100BS to return air vent collar. Return air vent collar will go around the ducting. Secure with duct tape.
3. Secure return air vent to soffit or ceiling with (4) screws.

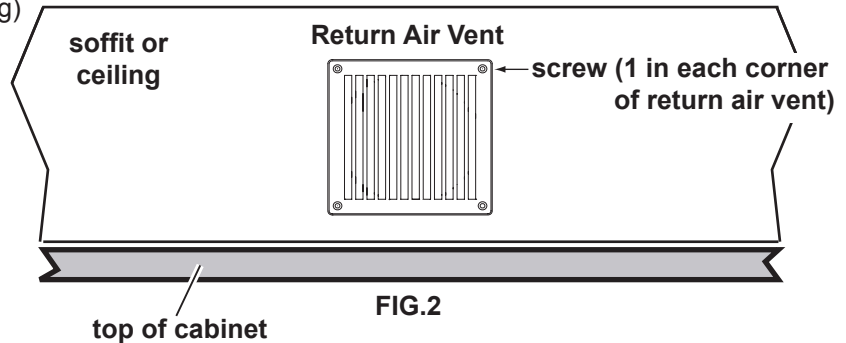

FIG.2

**note:** Return air vent deflectors should face the sides to properly vent the air. **FIG.3**

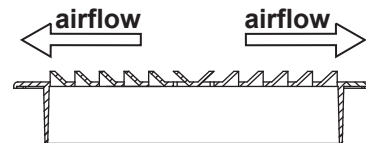

FIG.3