

Ductless recirculation is intended for applications where an exhaust duct work is not possible to be installed. When converted, the hood functions as a recirculating hood rather than an exhaust hood. Fumes and exhaust from cooking are drawn and filtered by a set of optional charcoal filters. The air is then purified and re-circulated back within the home.

We recommend to ALWAYS exhaust air outside of the home by employing existing or installing new duct work, if possible. The hood is most effective and efficient as an exhaust hood. Only when the exhaust option is not possible should you recourse to converting the hood into a recirculating hood.

When converted to be a recirculating hood, a set of charcoal filters are required on top of its standard Metal Filter set. Order according to its Part number below. The standard Metal Filters are intended to capture residue from cooking and the optional charcoal filters help to purify fumes exhausted from cooking for re-circulation.

RECIRCULATING KIT (REQUIRED IF NO DUCTING IS USED)

Kit includes charcoal filters and air diverter plate.

Hood Model	Part No.	Filters in Pkg.
ZNA-M90S	ZRC-0060	3
ZNA-E42S	ZRC-0060	3

1. Purchase recirculating kit per the part number above.
2. Secure air diverter plate to top support frame. (FIG. F) Open sides of air diverter plate should face left and right and align with louver holes on the duct covers. Run 6" ducting from top of blower housing and secure to air diverter plate. See manual included with recirculating kit for more detailed instructions.
3. Remove metal mesh filters from hood. Clip charcoal filters onto each charcoal filter bracket. (FIG. G) The brackets are pre-installed and located behind the mesh filters.
4. Re-install metal mesh filters.
5. Enable charcoal filter change indicator on control panel. (Refer details to pg. 13)
6. Charcoal filters must be replaced after every 120 hours of use (or approximately every 3 to 4 months based on the average of 1 to 2 hrs. of daily cooking time). The microprocessor in the controls when set, will elapse and count usage time and indicate when charcoal filter replacement is required every 120 hrs.

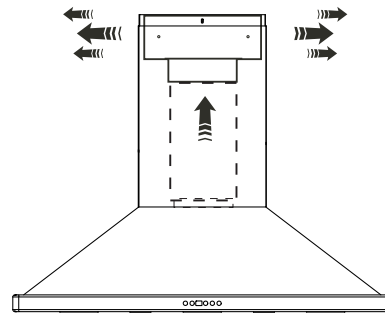
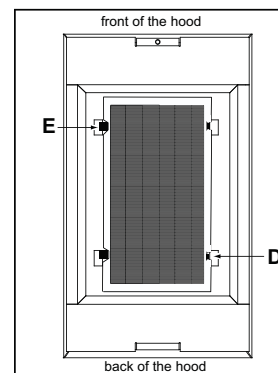

FIG. F



Install charcoal filter (plastic side exposed) into charcoal filter bracket. Insert tab cut-out side D of charcoal filter into bracket first. Lock charcoal filter into place by pushing down on side E with locking tabs.

FIG. G

Charcoal Filter Replacements

Hood Model	Part No.	Qty to Order
ZNA-M90S	Z0F-C002	3
ZNA-E42S	Z0F-C002	3

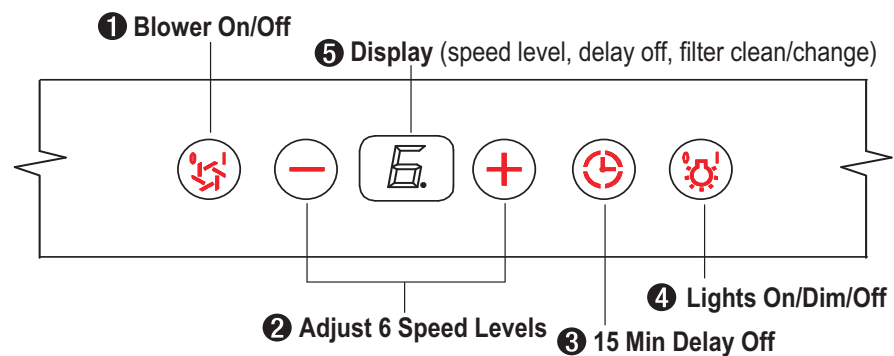

Charcoal Filter Dimensions:
 9in x 6 3/8in
 228mm x 162mm





1. Blower On/Off

By pressing  the blower is switched on and off. When switched on, the blower starts up on speed level 3.

2. Speed Selection

The 6 speed levels are selected by pressing  to decrease and  to increase speed levels. The display indicates levels selected.

3. Delay Off

This feature is used for programmed shut down of blower 15 minutes after the function is activated. Press  once, a dot flashes in the lower right side of display  indicating the function is on. The blowers will shut down after 15 minutes.

4. Lights On/Dim/Off

Switch lights on by pressing  once, press a second time to dim and again to shut off lights.

5. Display Window

The display window indicates speed levels and features such as metal filter clean reminder, delay off and charcoal filter change reminder.

Metal Filter Clean Reminder (metal mesh filter)

After every 30 hours of use the display will start flashing an  reminding you to clean the metal filters from residue and possible clogs.



The standard metal mesh filters are required to be cleaned frequently and as recommended in order to maintain blower efficiency. If improperly maintained, residue from cooking will sift through filters and cause damage to hood blowers and other sensitive components; and possible clog duct work and create a fire hazard.

Charcoal Filter Change Reminder (charcoal filter, if installed)

When your hood is installed as a recirculating unit, it is fitted with a set of charcoal filters to purify exhaust and fumes from cooking, then re-circulates the air within the home. These charcoal filters are required to be replaced after every 120 hours of use. The charcoal filters should never be cleaned or placed in a dish washer.

The filter change reminder function in the microprocessor needs to be switched on. When switched on, the microprocessor will elapse and count usage time and indicate by a flashing  when charcoal filter replacements are needed.

Setting the Filter Change Reminder

When off, hold  for approximately 5 seconds. The display will change from  (exhaust mode) to  (recirculating mode) this indicates that the elapse timer function is switched on and charcoal filters are used.

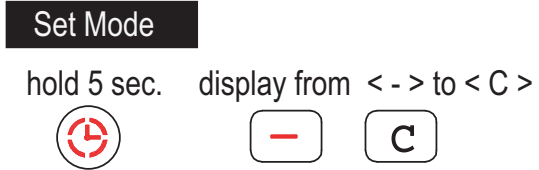



Filter Replace Indicator

When the display  starts flashing, the charcoal filters need to be replaced.



Re-setting Function

Once filters are replaced, with hood off, press and hold  the display will appear; hold for approximately 5 seconds until  on displays disappears  . The filter change reminder is now re-set and a new 120 hour elapse cycle is initiated.





Metal Filter Clean Reminder (metal mesh filter)

Whether your hood is installed as an exhaust or purifying unit, a set of metal mesh filters are fitted by the factory. These metal mesh filters are intended to filter out residue from cooking. They need not be replaced on a regular basis but are required to be kept clean. The filter clean reminder function in the microprocessor will automatically indicate by a flashing  when the metal mesh filters need to be cleaned after every 30 hours of use. Filters can be cleaned by hand with non-abrasive soap or in a dishwasher. Heavily soiled filters should also be soaked in grease cutting detergent prior to cleaning.

Metal Filter Clean Indicator

When  flashes on display, the metal filters installed are required to be cleaned. This will occur after every 30 hours of use.

Re-setting Function

Reset the filter clean reminder timer when filters are cleaned and re-installed (with hood off). Press and hold  for approximately 5 seconds, the display will appear; hold for approximately 5 seconds until  on display disappears . The filter clean reminder function is now reset and a new 30 hours elapse cycle is initiated.

Clean Filters

display < F > flashes

**To Reset**

hold 5 sec. display from < F > to < >



SURFACE MAINTENANCE:

Clean periodically with hot soapy water and clean cotton cloth. Do not use corrosive or abrasive detergent , or steel wool/scouring pads which will scratch and damage surface.

For heavier soil use liquid degreaser.

After cleaning it is recommended that you use non-abrasive stainless steel polish/cleaners, to polish and buff out the stainless luster and grain. Always scrub lightly, with clean cotton cloth, and with the grain.

Do not use any product containing chlorine bleach. Do not use “orange” cleaners.

Metal Filters

The metal filters installed by the factory are intended to filter out residue and grease from cooking. They need not be replaced on a regular basis but are required to be kept clean.

Filters should be cleaned after every 30 hours of use or once a month.

Remove and clean by hand or in dishwasher on low heat. Spray degreasing detergent and leave to soak if heavily soiled.

Dry filters and re-install before using hood.

Replacing Metal Filters

Should filters wear out due to age and prolonged use, replace with following part number:

Hood Model:	Part No.	Qty. to Order.
ZNA-M90S	50200004	3
ZNA-E42S	50200004	3

Replace any damaged filter that has punctured or broken mesh or damaged frame.

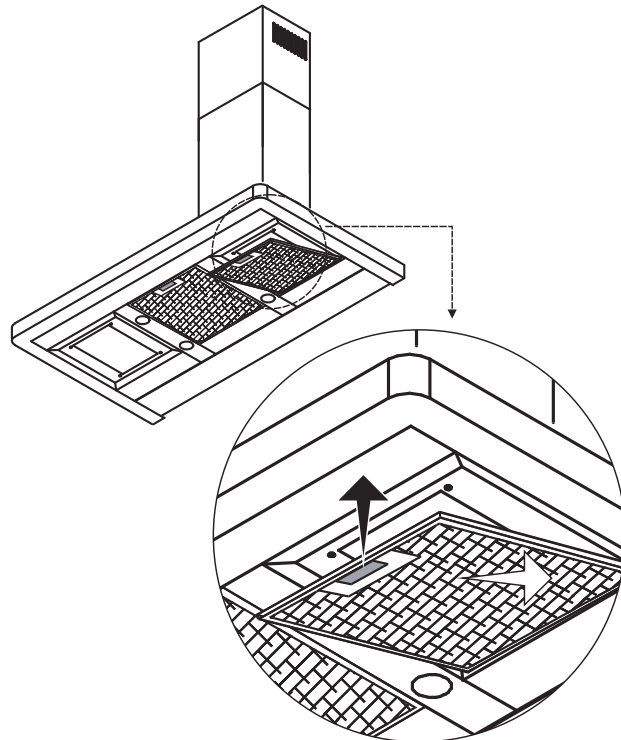

REPLACING LIGHT BULBS

CAUTION: Light bulb becomes extremely hot when turned on.

DO NOT touch bulb until switched off and cooled. Touching hot bulbs could cause serious burns.

Make sure all power is turned off and bulbs are not hot.

Remove by turning bulb counter clockwise. Note: Bulb does not unscrew; it turns 60 degrees, stops and falls out.

If bulbs are difficult to turn due to prolonged use, firmly attach a glass suction cup approximately the diameter of the bulb or use a rubber/latex glove and turn counter clockwise.

Replacement bulbs are available at specialty lighting stores. Purchase type GU-10 50W halogen. Note: GU-10 halogen light bulbs apply to ZNA hoods ending in serial number xxxxxxxBxx only.

For Zephyr part numbers please turn to page 18 of the manual.

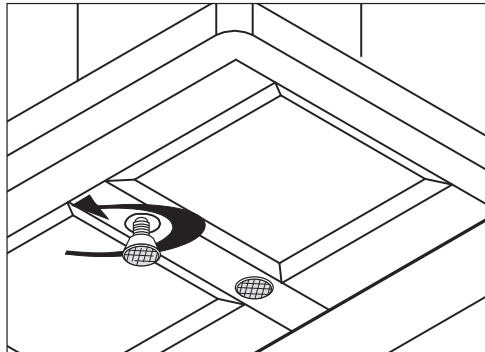

TROUBLESHOOTING PROCEDURES FOR NAPOLI ISLAND

Issue	Cause	What to do
After installation, the unit doesn't work.	1. The power source is not turned ON.	1. Make sure the circuit breaker and the unit's power is ON.
	2. The power line and the cable locking connector is not connecting properly.	2. Check the power connection with the unit is connected properly.
	3. The switch board and control board wirings are disconnected.	3. Make sure the wirings between the switch board and control board are connected properly.
	4. The switch board or control board is defective.	4. Change the switch board or control board.
Light works, but motor is not turning.	1. The motor is defective, possibly seized.	1. Change the motor.
	2. The thermally protected system detects if the motor is too hot to operate and shuts the motor down.	2. The motor will function properly after the thermally protected system cool down.
	3. Damaged capacitor.	3. Change the capacitor.
	4. The switch board or control board is defective.	4. Change defective part.
The unit is vibrating.	1. The motor is not secure in place.	1. Tighten the motor in place.
	2. Damaged blower wheel.	2. Replace the blower.
	3. The hood is not secured in place.	3. Check the installation of the hood.
	4. The switch board or control board is defective.	4. Change defective part.
The motor is working, but the lights are not.	1. Defective halogen bulb.	1. Change the halogen bulb.
	2. The light bulb is loose.	2. Tighten the light bulb.
The hood is not venting out properly.	1. The hood might be hanging to high from the cook top.	1. Adjust the distance between the cook top and the bottom of the hood within 28" and 36" range.
	2. The wind from the opened windows or opened doors in the surrounding area are affecting the ventilation of the hood.	2. Close all the windows and doors to eliminate the outside wind flow.
	3. Blockage in the duct opening or ductwork.	3. Remove all the blocking from the duct work or duct opening.
	4. The direction of duct opening is against the wind.	4. Adjust the duct opening direction.
	5. Using the wrong size of ducting.	5. Change the ducting to at least 6" or higher for the internal blower and 8" or higher for the external blower.
Metal Filter is vibrating.	1. Metal filter is loose.	1. Change the metal filter.

List of Parts and Accessories

DESCRIPTION	PART#
Replacement Parts	
Light Bulb GU10 50W (each)	Z0B-0020S
Metal Filter (each)	50200004
Optional Accessories	
Recirculating Kit	ZRC-0060
Replacement Charcoal Filter (each)	Z0F-C002
Duct Cover Extension	Z1C-00NA

To order parts, visit us online at <http://store.zephyronline.com> or call us at 1.888.880.8368